



US007509692B2

(12) **United States Patent**
Elkins et al.

(10) **Patent No.:** **US 7,509,692 B2**

(45) **Date of Patent:** **Mar. 31, 2009**

(54) **WEARABLE PERSONAL COOLING AND HYDRATION SYSTEM**

5,062,269 A 11/1991 Siegel
5,146,757 A * 9/1992 Dearing 62/61

(75) Inventors: **William Elkins**, Lincoln, CA (US);
Kenneth L. Blanchard, Vacaville, CA (US);
Maurice Jordan, Antioch, CA (US)

(Continued)

FOREIGN PATENT DOCUMENTS

(73) Assignee: **bioCOOL technologies, LLC**,
McClellan, CA (US)

WO WO 03/102480 12/2003

(*) Notice: Subject to any disclaimer, the term of this patent is extended or adjusted under 35 U.S.C. 154(b) by 563 days.

(Continued)

OTHER PUBLICATIONS

(21) Appl. No.: **11/127,866**

(22) Filed: **May 11, 2005**

Life Support Systems, Inc.; M2DS Cooling System Price List; Jan. 1, 1994.

(65) **Prior Publication Data**

US 2006/0191049 A1 Aug. 31, 2006

(Continued)

Related U.S. Application Data

(60) Provisional application No. 60/570,401, filed on May 11, 2004.

Primary Examiner—Amy B Vanatta
(74) *Attorney, Agent, or Firm*—Heisler & Associates

(51) **Int. Cl.**
A41D 1/04 (2006.01)
F28F 7/00 (2006.01)

(52) **U.S. Cl.** **2/458; 2/102; 2/7; 165/46; 62/259.3**

(58) **Field of Classification Search** **2/458, 2/7, 8, 84, 108, 69, 102, 81, 85, 93, 94; 165/46, 165/297, 104.14, 120, 296, 170, 138; 62/259.3, 62/530; 224/148.1–148.7; 607/104, 108–110, 607/114**

See application file for complete search history.

(57) **ABSTRACT**

A heat transfer fluid pathway is provided driven by a pump which feeds the heat transfer fluid through a vest and cap or other heat transfer garment, where the heat transfer fluid draws heat away from the body of the wearer. A drinkable heat sink material is located within a removable cartridge located within a heat exchange pouch. The heat transfer fluid passes from the heat transfer garment to the heat exchange pouch where heat drawn from the wearer is transferred to the heat sink material within the cartridge. A temperature control valve is provided along with a bypass line so that an adjustable amount of the heat transfer fluid is routed to the heat exchange pouch for temperature control. A supply of elevated pressure air is optionally provided to maintain optimal contact for efficient heat transfer within the heat exchange garment and the heat exchange pouch.

(56) **References Cited**

U.S. PATENT DOCUMENTS

4,149,541 A 4/1979 Gammons
4,691,762 A 9/1987 Elkins
4,856,294 A 8/1989 Scaringe

17 Claims, 9 Drawing Sheets

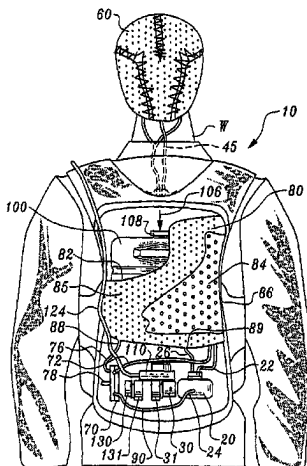

U.S. PATENT DOCUMENTS

5,201,365 A * 4/1993 Siegel 165/46
5,224,349 A 7/1993 Siegel
5,524,293 A 6/1996 Kung
5,901,889 A 5/1999 Ho
5,967,225 A * 10/1999 Jenkins 165/46
6,178,562 B1 1/2001 Elkins
6,220,490 B1 * 4/2001 O'Hara 224/148.2
6,276,155 B2 * 8/2001 Siman-Tov et al. 62/259.3
6,497,348 B2 12/2002 Forsman
6,942,015 B1 * 9/2005 Jenkins 165/46
6,993,930 B2 * 2/2006 Blackstone 62/421
2003/0019476 A1 * 1/2003 Chambers 123/438
2004/0079517 A1 4/2004 Bueley
2004/0128747 A1 * 7/2004 Bumbarger et al. 2/458

FOREIGN PATENT DOCUMENTS

WO WO 2004/033044 4/2004

OTHER PUBLICATIONS

Life Support Systems, Inc.; Maintenance Operations Manual for the M2DS MultiCrew MicroClimate Drinking System; Sep. 1993.
Life Support Systems, Inc.; Integrated Cooling System Price List; Jan. 1, 1993.
Life Support Systems, Inc.; Integrated Cooling System Product Sheet; Circa 1993.
National Aeronomics and Space Administration; Spinoff 93; Cover and pp. 54-55; 1993.
Huan Wang, M.D., et al.; Rapid and Selective Cerebral Hypothermia Achieved Using a Cooling Helmet; J. Neurosurg.; Feb. 2002; pp. 272-277; vol. 100.

* cited by examiner

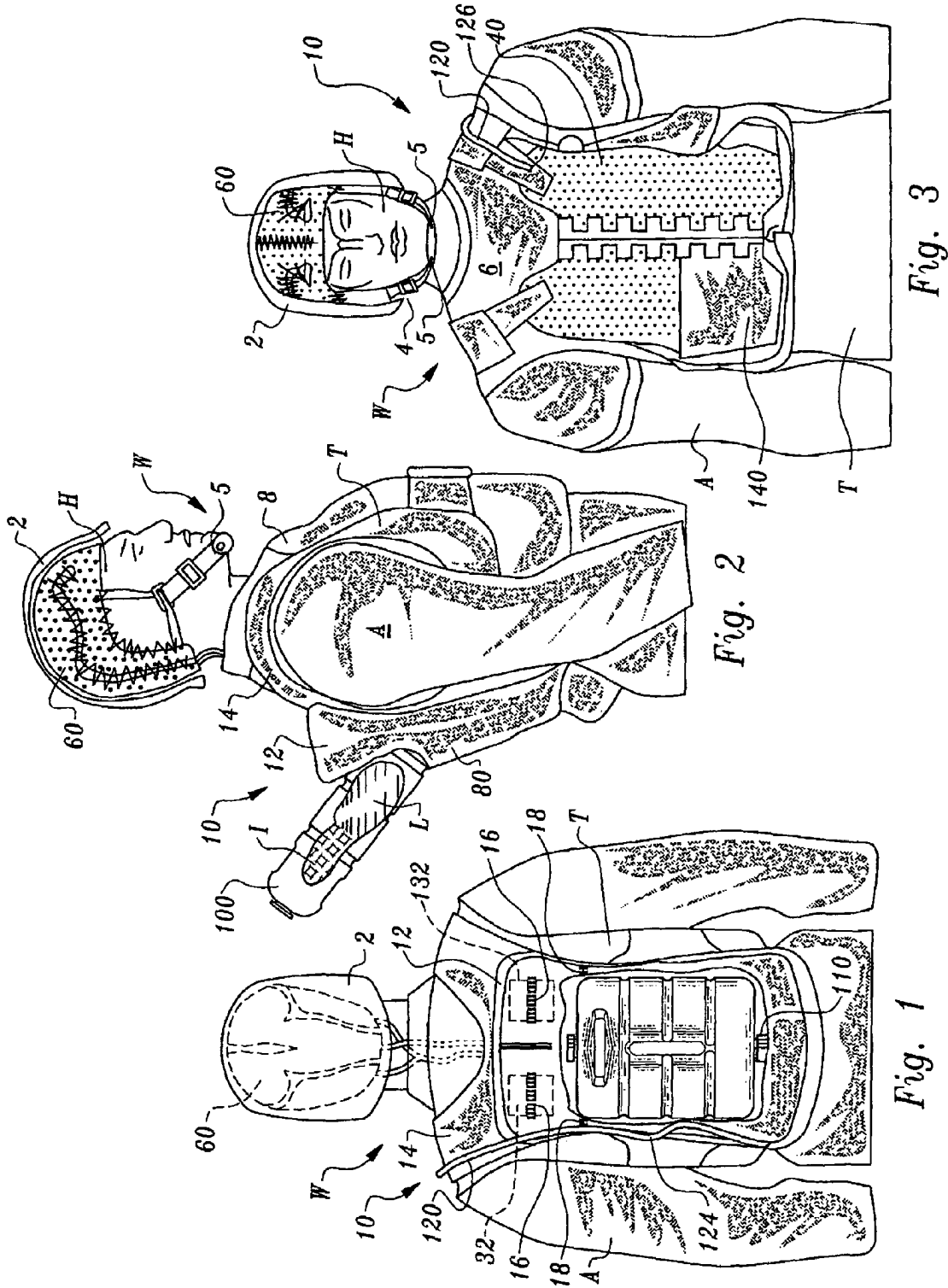

Fig. 1

Fig. 2

Fig. 3

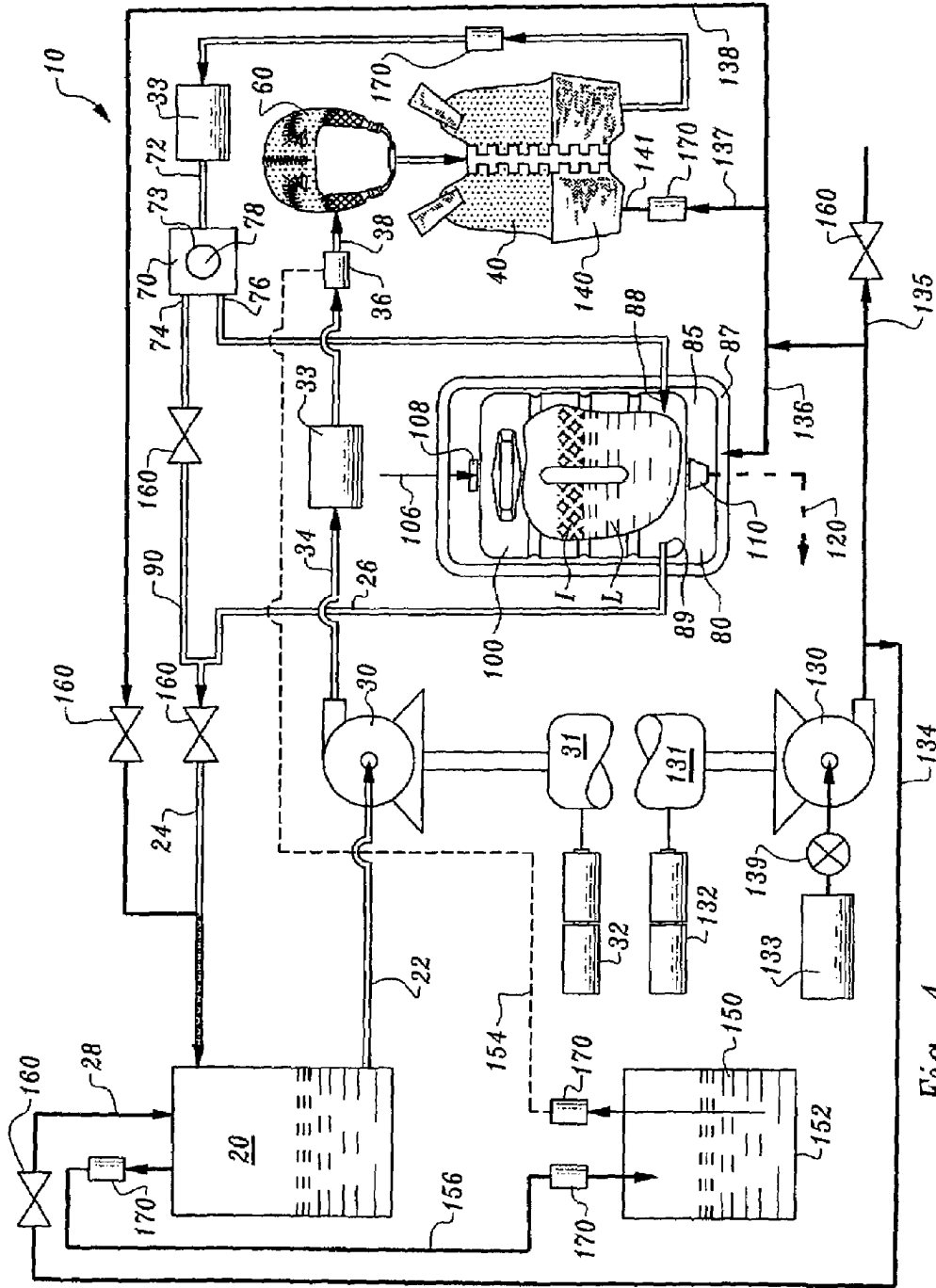

Fig. 4

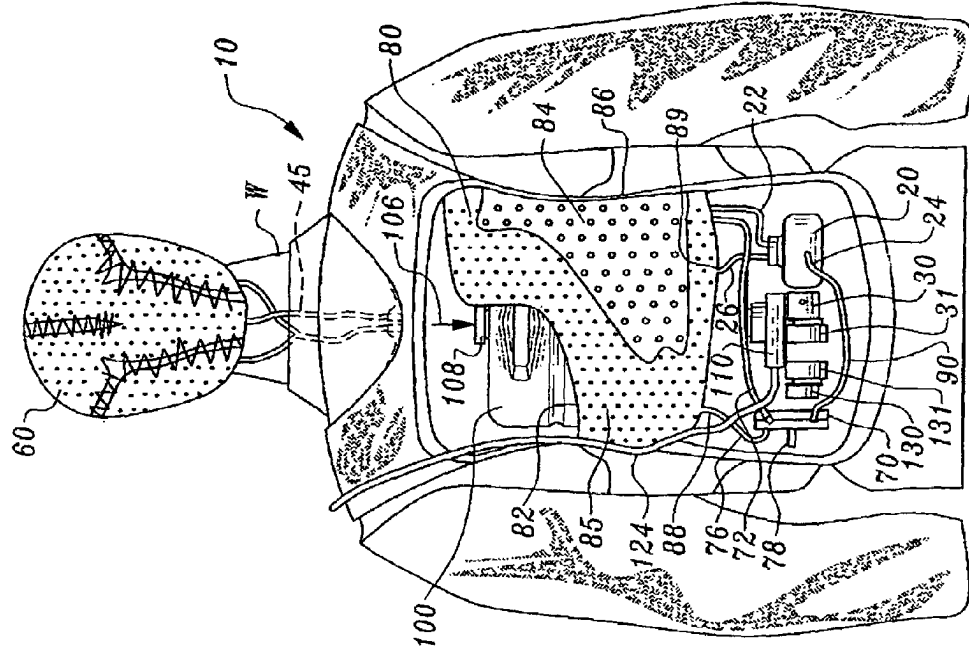

Fig. 6

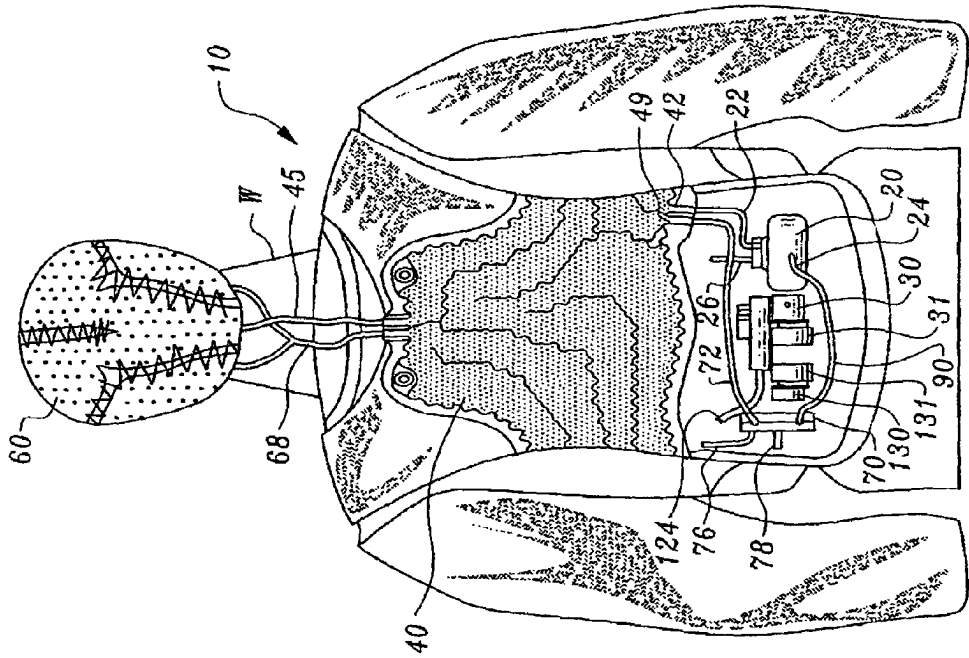

Fig. 5

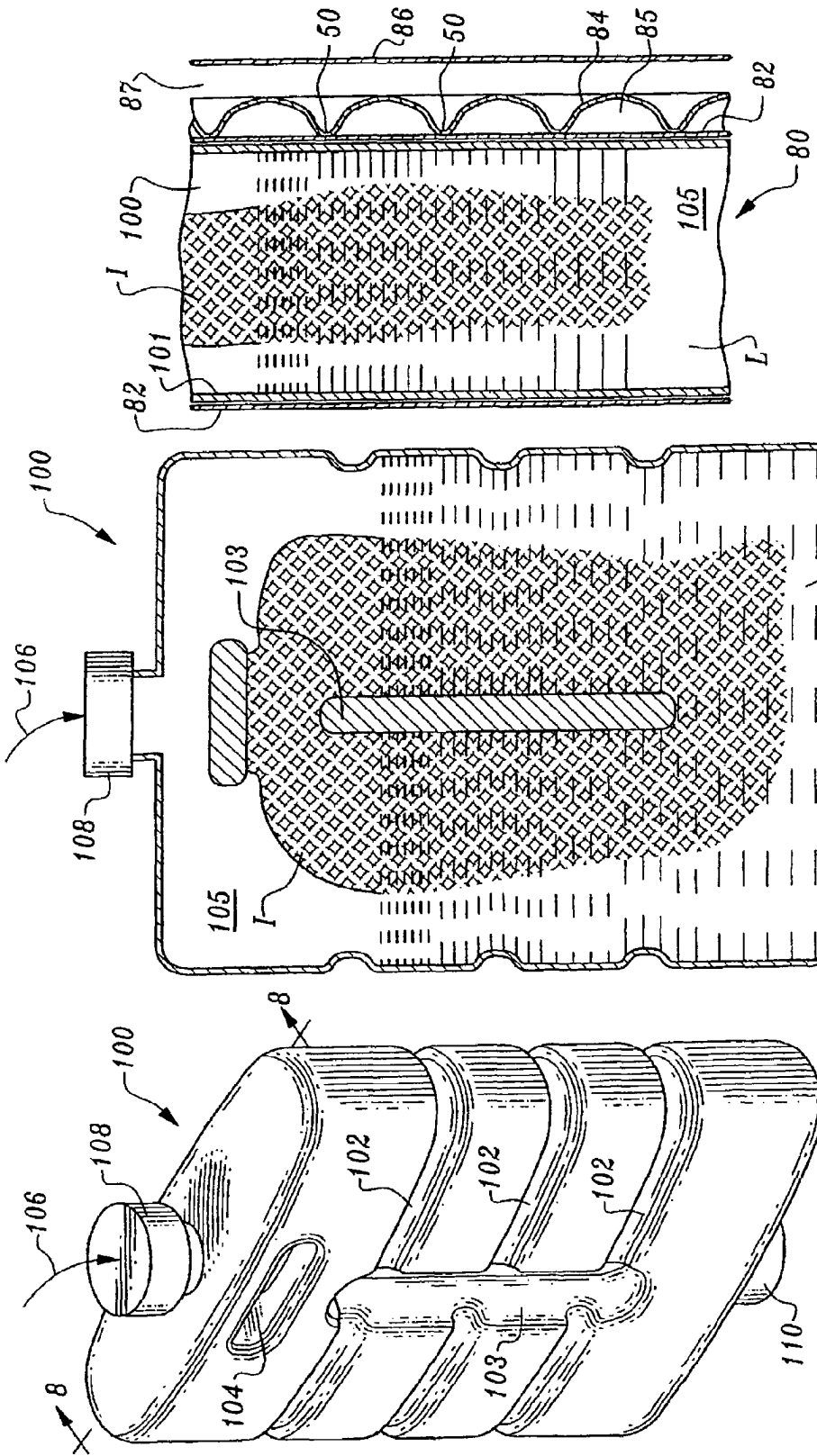

Fig. 9

Fig. 8

Fig. 7

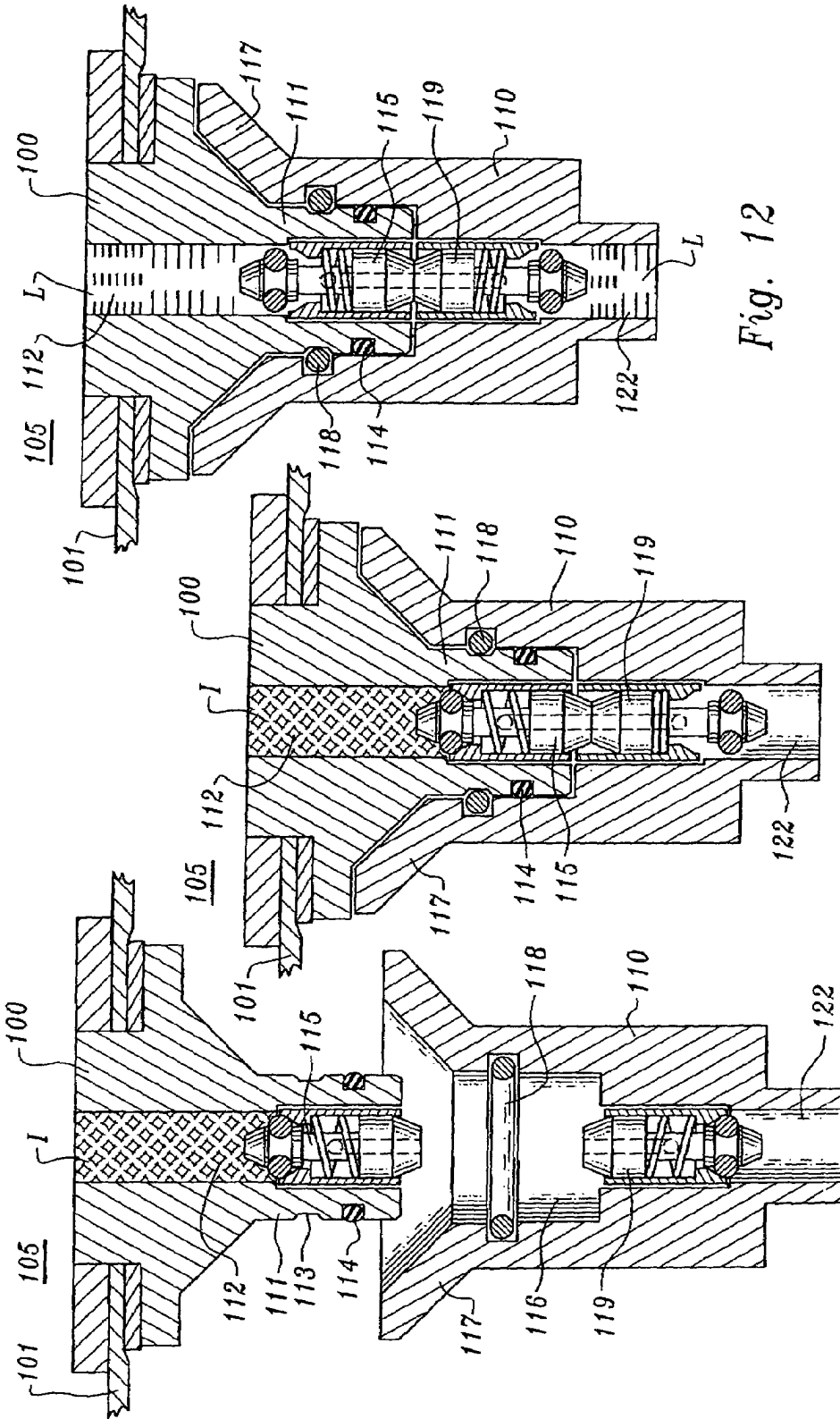

Fig. 12

Fig. 11

Fig. 10

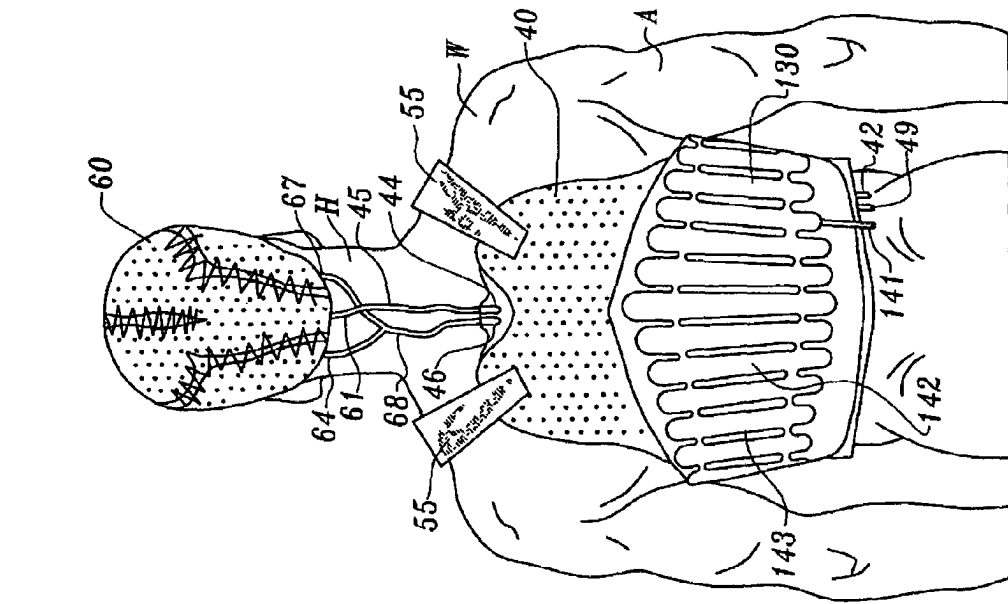

Fig. 13

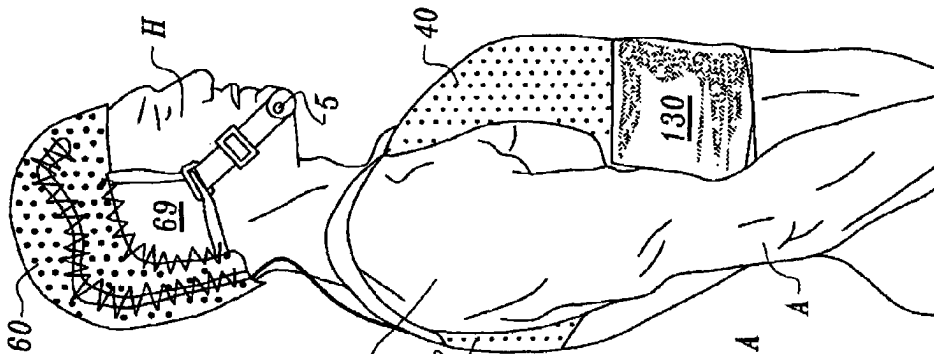

Fig. 14

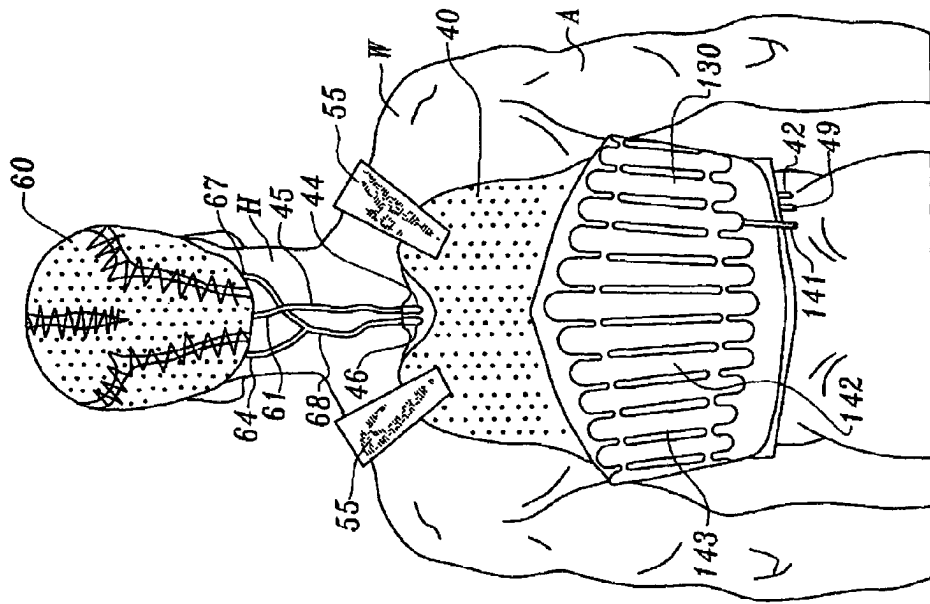

Fig. 15

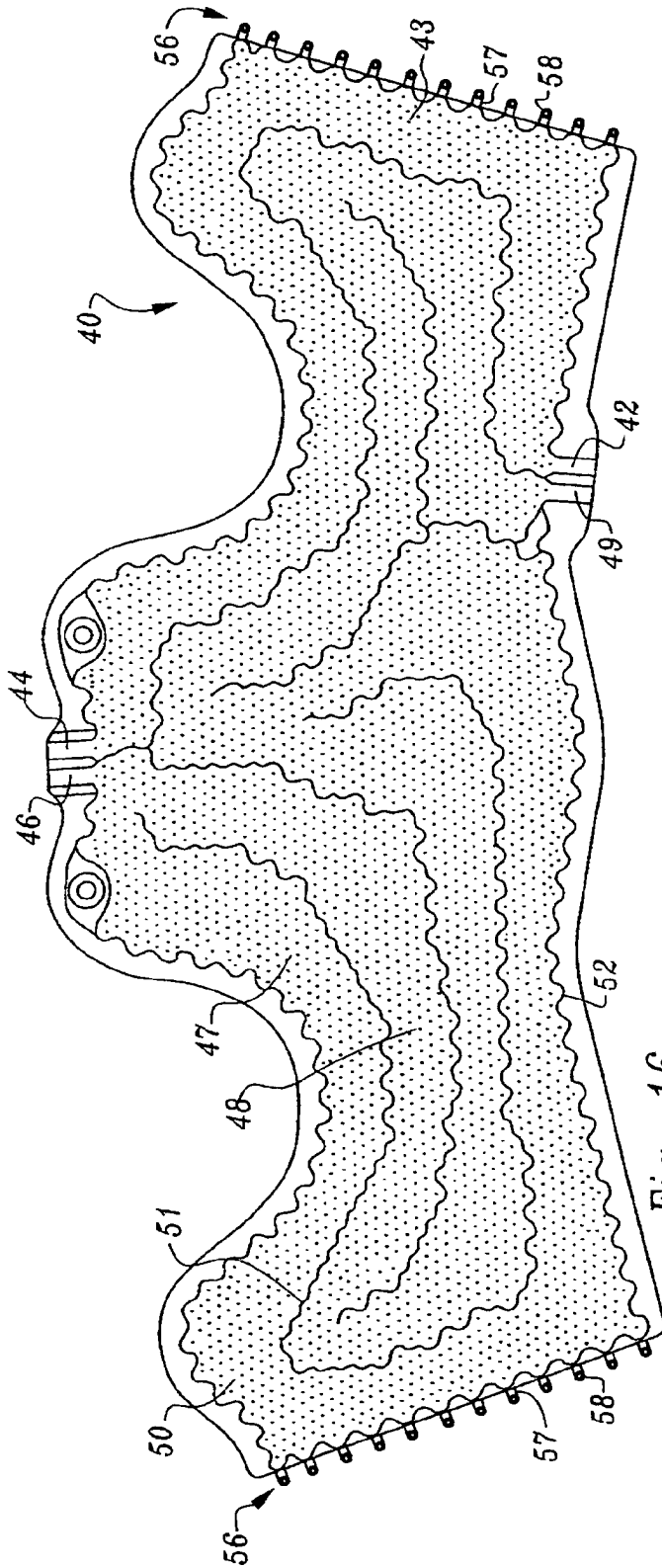

Fig. 16

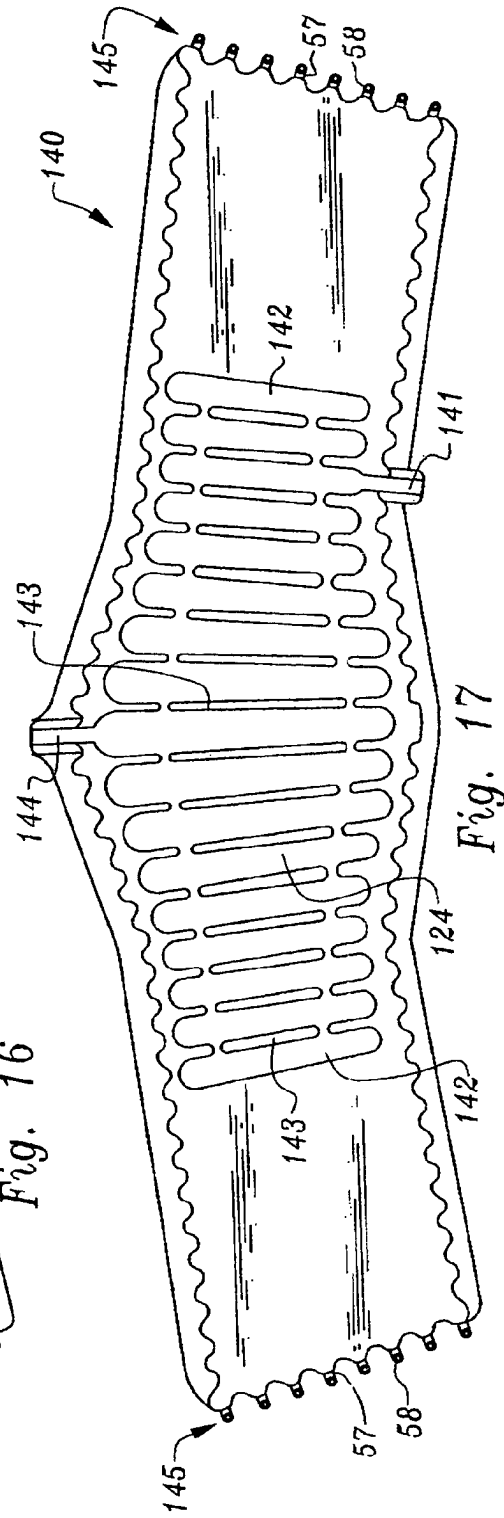

Fig. 17

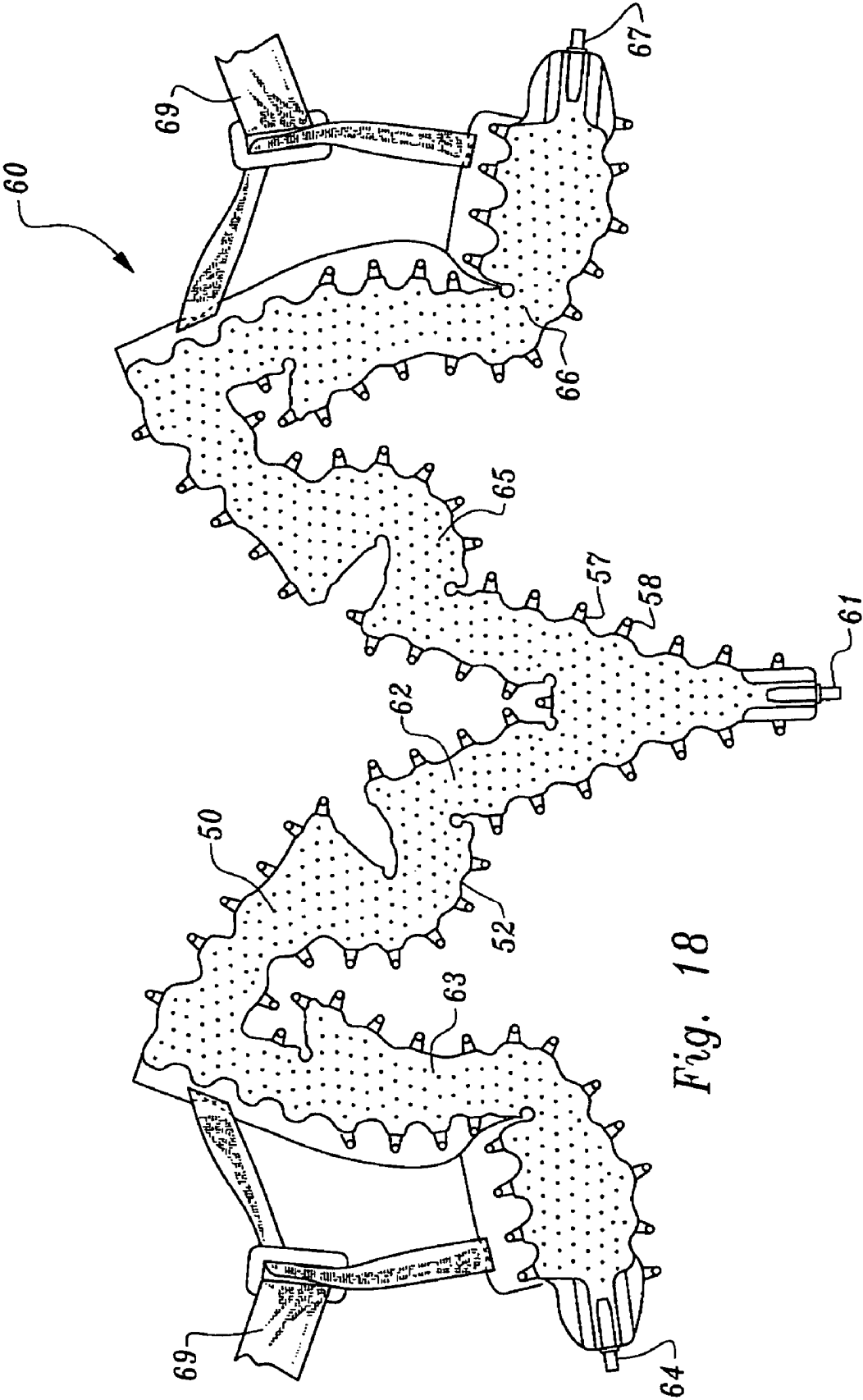

Fig. 18

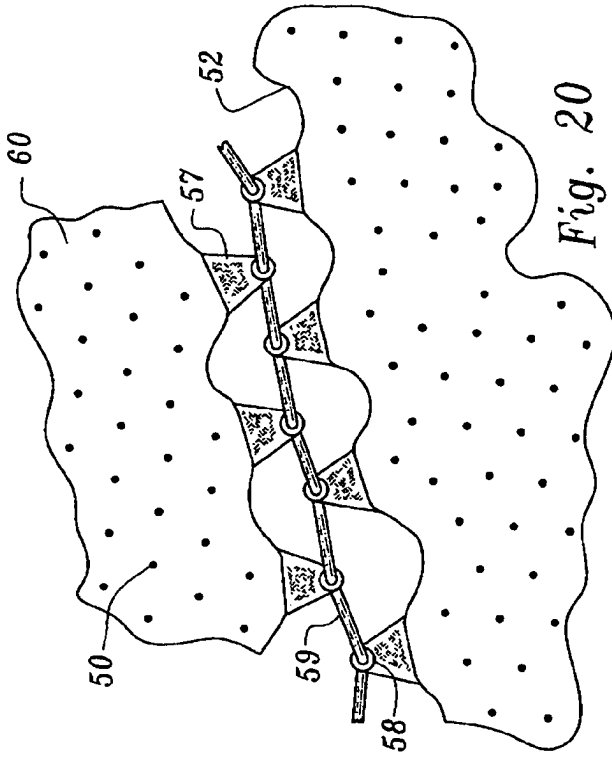

Fig. 20

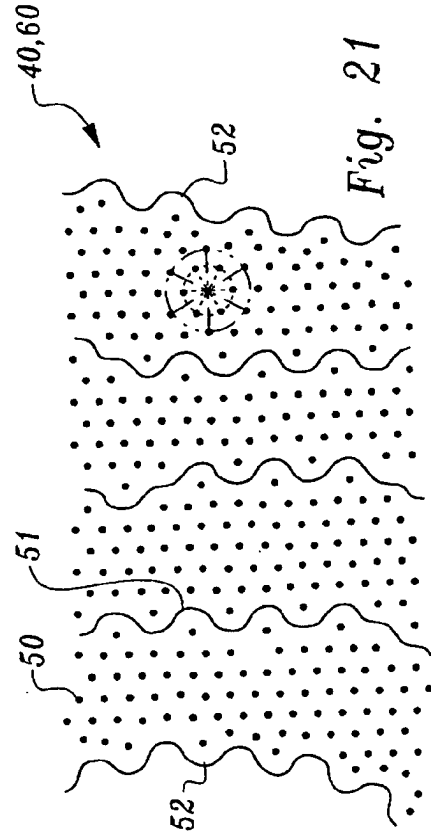

Fig. 21

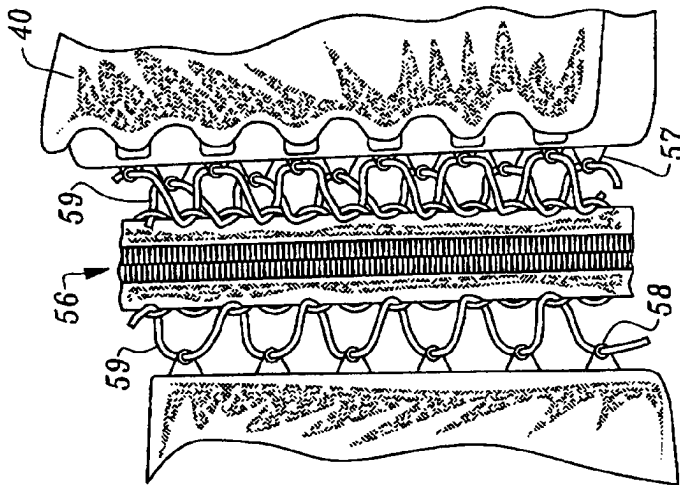

Fig. 19

1

**WEARABLE PERSONAL COOLING AND
HYDRATION SYSTEM****CROSS-REFERENCE TO RELATED
APPLICATIONS**

This application claims benefit under Title 35, United States Code §119(e) of U.S. Provisional Application No. 60/570,401 filed on May 11, 2004.

FIELD OF THE INVENTION

The following invention relates to heat transfer systems, and particularly cooling systems for cooling an individual, and which are worn by the individual. More particularly, this invention relates to wearable cooling systems and associated garments, such as to maintain comfort and personal performance in high temperature environments.

BACKGROUND OF THE INVENTION

The human body is only capable of effective performance and survival within a relatively narrow range of temperatures. Hence, the body includes temperature control systems to maintain optimal bodily function and health. In particular, the human body is configured to sweat moisture through the skin so that when this moisture evaporates, evaporative cooling takes place on the surface of the skin to cool the individual. When excessive cold is encountered, the body may initiate a shivering reflex such that additional heat is generated to compensate. These and other body temperature systems are not entirely adequate to deal with all of the ranges of temperature which a human is likely to encounter in many circumstances. Hence, it has been known throughout the ages for individuals to augment their own body temperature control systems with appropriate clothing. When colder temperatures are encountered, warmer clothing is worn. When hotter temperatures are encountered less and lighter clothing is worn; or alternatively clothing which tends to reflect sunlight or which enhances the prevalence of shade.

While the wearing of different amounts of clothing is generally effective in compensating for excessively cold environments, climates exist where temperatures are sufficiently high that clothing modifications alone are not sufficient to maintain optimal body temperature and personal performance. In particular, deserts present a challenging environment in that temperatures up to or even exceeding 140 degrees Fahrenheit can be encountered. When other features of the desert environment (including lack of trees or other shade structures, and radiation of heat from the ground and surrounding structures) is taken into account, the heat load on an individual can further tax the natural and artificial systems used by the individual to maintain adequate body temperature for optimal personal performance in the desert environment.

In such environments the evaporative cooling associated with sweating and maintaining body temperature requires that exceptionally large amounts of fluids be consumed. With the consumption of such large amounts of liquid, electrolyte balances within the individual are difficult to maintain and other difficulties are also encountered, including the uncomfortableness associated with excessive sweating. Accordingly, a need exists for improved systems for actively cooling the body of an individual when the individual is in a high temperature environment, such as a desert.

Likewise, hot jungle temperatures, although lower than in the desert, with humidity approaching 100% and eliminating

2

effective use of evaporative cooling of the body by sweat or by artificial evaporation of water, present a need for improved body cooling systems.

SUMMARY OF THE INVENTION

With this invention, a personal cooling and hydration system is provided which can be worn by the user and both provides cooling for the user and a source of drinkable fluid to augment the body's natural temperature control systems. A vest and cap or other garment is worn by the user which includes a heat transfer fluid pathway extending there-through. The heat transfer fluid passes through this pathway and absorbs heat from the wearer.

Preferably, this garment is in the form of both a vest and a cap so that heat absorption into the heat transfer fluid and cooling for the wearer can be maximized. This thus heated heat transfer fluid is then routed to a heat sink where the heat transfer fluid is cooled and the heat in the heat transfer fluid is passed to the heat sink material.

The heat sink is preferably in the form of a removable cartridge which can be worn by the wearer, preferably within a backpack. This heat sink cartridge is preferably a water or other drinkable fluid container which begins in the form of ice. As the heat transfer fluid draws heat away from the wearer and delivers it to the heat sink, the ice melts. A drinking tube is coupled to an outlet of the cartridge so that the wearer (or others) can utilize the drinking tube to drink fresh recently melted water. The cooled heat transfer fluid then returns back to the garment for further cooling of the wearer.

Most preferably, not all of the heat transfer fluid is routed to the heat sink, such as the water/ice filled cartridge. Rather, two parallel paths are provided for the heat transfer fluid, including a hot path which bypasses the heat sink and a cold pack which is routed to the heat sink. A temperature control valve divides the flow of heat transfer fluid between the hot and the cold path. Preferably, this temperature control valve is adjustable by the user, so that the user can select the amount of heat transfer fluid which is cooled, and correspondingly control a rate at which heat is drawn from the wearer and delivered to the heat sink.

The heat sink material, preferably in the form of the drinkable fluid such as water, is contained within a cartridge which can be removed from a pouch in the backpack, such as when it has been depleted. A new cartridge can then be placed into the backpack so that cooling of the heat transfer fluid can continue. In this way, the wearer can maintain adequate temperature control for long periods of time without being required to carry a large cartridge of heat sink material.

The garment through which the heat transfer fluid flows to draw heat from the wearer preferably is configured as a pair of layers spaced apart by a heat transfer fluid space. A plurality of dots connect the two layers together. These dots help to maintain a generally planar form of the garment and assist in mixing of the heat transfer fluid for maintenance of a uniform temperature for the heat transfer fluid.

Fences are also preferably provided extending between the inner and outer layers of the garment. These fences divide the heat transfer space into pathways so that the heat transfer fluid can be effectively routed without pockets of stagnation, and so that the heat transfer fluid most effectively draws heat away from the wearer and flows to the heat sink for cooling of the heat transfer fluid. These garments can particularly be configured as a vest portion, a cap portion, or other portions, depending on the particular performance needs for the garment.

Optionally, elevated pressure air can be provided to enhance surface contact between the heat transfer fluid pathway and the heat sink, and between the garment and the wearer so that rates of heat transfer can be maximized. Pumps and associated power supplies are included in a backpack with the heat sink material cartridge to power circulation of the heat transfer fluid and optionally compressed air to facilitate fluid flow according to this invention.

OBJECTS OF THE INVENTION

Accordingly, a primary object of the present invention is to provide a system for both cooling and hydrating an individual operating within a high temperature environment.

Another object of the present invention is to provide a cooling and hydration system which is wearable by the user.

Another object of the present invention is to provide a system to facilitate optimal functioning of a human within exceptionally high temperature environments, such as deserts.

Another object of the present invention is to provide a wearable cooling and hydration system which can be quickly and easily recharged when depleted.

Another object of the present invention is to provide a cooling and hydration system which can be worn by a user in a convenient fashion which avoids interfering with the functions being preformed by the wearer.

Another object of the present invention is to provide a cooling and hydration system suitable for use by armed services personnel while conducting operations in high temperature environments, such as deserts and jungles.

Another object of the present invention is to provide a cooling and hydration system which cools both a head and torso of the wearer.

Another object of the present invention is to provide a cooling and hydration system which is controllable by a user for maximum comfort.

Another object of the present invention is to provide a cooling and hydration system which can operate in contaminated environments with minimum contamination of the system, and particularly drinking water within the system.

Another object of the present invention is to provide a cooling and hydration system which is adapted for use by athletes and other individuals undergoing rigorous exercise or exercise in high temperature environments.

Another object of the present invention is to provide a cooling and hydration system for use by laborers who are required or benefit from the ability to work in high temperature environments with a high degree of capability.

Another object of the present invention is to provide a cooling and hydration system for use by a wearer who suffers from a medical condition where cooling of the body provides a therapeutic effect, such as multiple sclerosis.

Another object of the present invention is to provide a cooling and hydration system which can either be entirely worn by the user or can be divided into two parts with a portion providing heat transfer from the body of the wearer being worn, and with a heat sink portion being either wearable or carryable by the user or upon some load carrying vehicle, or resting on the ground adjacent the individual to be cooled, when the individual is working at a single location or within sufficiently close proximity to a single location that conduits can pass from the heat sink portion to the individual being cooled.

Other further objects of the present invention will become apparent from a careful reading of the included drawing figures, the claims and detailed description of the invention.

BRIEF DESCRIPTION OF THE DRAWINGS

FIG. 1 is a rear elevation view of the system of this invention while being worn by a wearer and with portions of a backpack bearing the system cut away to reveal interior details thereof, and with portions of the system shown in broken lines.

FIG. 2 is a side elevation view of that which is shown in FIG. 1 and with a cartridge containing the heat sink material shown partially removed from a backpack portion of the invention, and with portions of a helmet of a wearer cutaway to reveal details of the cap for cooling the head of the wearer.

FIG. 3 is a front elevation view of that which is shown in FIGS. 1 and 2, and with portions cut away to reveal details of the vest, cap, and cummerbund according to this invention.

FIG. 4 is a schematic of the overall cooling and hydration system showing the flow pathways and associations between the components of the system of this invention.

FIG. 5 is a rear elevation view of this invention with portions of the backpack cut away and to reveal details of the vest and heat transfer fluid handling equipment.

FIG. 6 is a rear elevation view similar to that which is shown in FIG. 5, but with less of the system cutaway, such that portions of the heat sink cartridge and portions of a pouch in which the heat sink cartridge resides are shown, as well as heat transfer fluid handling equipment according to the system of this invention.

FIG. 7 is a perspective view of the heat sink material cartridge of this invention.

FIG. 8 is a full sectional view of that which is shown in FIG. 7, and revealing that the heat sink material is in a partially liquid and partially solid (ice) state.

FIG. 9 is a side partial section of the cartridge of this invention as well as portions of the pouch and backpack surrounding the cartridge.

FIGS. 10 through 12 are full sectional views of a heat sink material outlet valve between the cartridge and drinking tube of this invention and showing in detail how the valves therein go from a closed to an open position to facilitate drinking of the heat sink material.

FIG. 13 is a front elevation view of the vest and cap portions of this invention alone upon the wearer.

FIG. 14 is a side elevation view of that which is shown in FIG. 13.

FIG. 15 is a rear elevation view of that which is shown in FIG. 13.

FIG. 16 is a top plan view of the vest of this invention shown off of the wearer and laid flat, and with an outer layer thereof removed to reveal interior pathways, fences and dots within the vest.

FIG. 17 is a top plan view of the cummerbund of this invention with an outermost layer removed to reveal interior details thereof.

FIG. 18 is a top plan view of the cap of this invention laid flat and entirely unlaced, and with an outer layer removed to reveal a preferred dot pattern and pathway configuration for the cap of this invention.

FIG. 19 is a detail of a portion of the vest of this invention as well as a sternum joint, revealing in detail how the vest is secured to the wearer.

FIG. 20 is a detail of a portion of a seam between adjacent pathways on the cap of this invention and revealing in detail how seams within the cap of this invention are drawn closed.

FIG. 21 is a detail of a portion of the vest or cap of this invention particularly revealing how the dots and fences or borders are arranged according to this invention.

DESCRIPTION OF THE PREFERRED EMBODIMENT

Referring to the drawings, wherein like reference numerals represent like parts throughout the various drawing figures, reference numeral **10** is directed to the cooling and hydration system of this invention (FIGS. **1** through **4**). With this system **10**, the wearer **W** has both the wearer's body cooled to maintain comfort and optimal performance, as well as being provided with a source of hydration for the wearer **W**. The wearer **W** can thus maintain optimal performance even in exceptionally high temperature environments, such as deserts or tropical environments.

In its essence, and with particular reference to FIG. **4**, details of the operation of the overall system of this invention are described. The system **10** includes a heat transfer fluid with begins within a reservoir **20**. A heat transfer fluid pump **30** draws the heat transfer fluid out of the reservoir **20** and delivers it to a garment worn by the wearer **W** (FIG. **1**). This garment typically and preferably includes both a vest **40** and a cap **60**. Within the vest **40** and cap **60** the heat transfer fluid heats up as it draws heat away from the body of the wearer **W** through the vest **40** and cap **60**. The wearer **W** is thus cooled a corresponding amount.

The heated heat transfer fluid then passes to a temperature control valve **70**. The temperature control valve **70** selectively directs a portion of the heat transfer fluid along a cold path to a heat exchange pouch **80** for cooling and a portion along a hot path bypass line **90** for return back to the reservoir **20** without cooling. The heat transfer fluid which is directed from the temperature control valve **70** to the heat exchange pouch **80** passes adjacent a cartridge **100** filled with a heat sink material, preferably of initially water ice **I**. The heat transfer fluid thus gives up its heat to the ice **I**, causing the ice to melt into liquid water **L**, and cooling the heat transfer fluid before it returns back to the reservoir **20**. When the heat transfer fluid again leaves the reservoir **20** it has been cooled and so is capable of further cooling of the wearer **W** when re-circulating back to the vest **40** and cap **60**. As the water **L** within the cartridge **100** melts, its passes through the water outlet valve **110** and is available for drinking from the drinking tube **120**.

An air pump **130** is optionally provided which can deliver air to the heat exchange pouch **80** to maximize contact and heat transfer between the heat transfer fluid and the heat sink material within the cartridge **100**, and can also optionally be fed to a cummerbund **140** to apply pressure against the vest **40** to maximize heat transfer between the torso **T** of the wearer **W** and the vest **40**.

The system **10** preferably includes a heat transfer filler source **150** which can be initially provided and periodically provided thereafter to charge or recharge the system with heat transfer fluid. Various check valves **160** maintain fluid flow and air flow in the desired directions. Various miscellaneous disconnects **170** are provided within the system **10** at locations where the system **10** requires frequent separation, such as when the backpack **12** (FIG. **1**) including the cartridge **100** and pumps **30**, **130** need to be removed, but the wearer wishes to keep the vest **40** and cap **60** on.

More specifically, and with particular reference to FIGS. **1** through **3**, the general features of this invention are further shown in particular relationship with the body of the wearer **W** utilizing the system **10**. The wearer **W** would typically be a human individual with head **H**, arms **A** and torso **T**. In the particular embodiment depicted, the wearer **W** is generally equipped as a soldier and including a helmet **2** adapted to overlie the cap **60**. The helmet **2** includes straps **4** for securing under a chin of the head **H**. Most preferably, snaps **5** are

provided on a chin strap portion of the cap **60** with the snaps **5** available for connecting to the straps **4** of the helmet **2**. In this way, the straps **4** of the helmet **2** do not need to also pass under the chin of the wearer **W**, but merely attach to the ear covers with chin straps **69** of the cap **60** (FIG. **18**).

The wearer **W** would typically wear an undershirt **6** underneath all of the different portions of the system **10**. The vest **40** and optional cummerbund **140** would then be placed on the wearer **W** overlying the undershirt **6**, and beneath an over shirt **8**. Portions of the system **10** such as the drinking tube **120** would be preferably integrated with the straps **4** of the backpack **12** and be located primarily on an exterior of the over shirt **8**.

The remaining portions of the system are preferably configured within a backpack **12** which is worn on an exterior of the over shirt **8** and overlying a back of the wearer **W**. The backpack **12** includes straps **14** riding over shoulders of the wearer **W**. Generally, the backpack **12** includes a pair of top zippers **16** which allow access to compartments for batteries **32**, **132** to power the heat exchange fluid pump **30** and air pump **130**. The backpack **12** additional includes a large zipper **18** providing access into the heat exchange pouch **80** (FIGS. **6** and **9**). This pouch **80** is adapted to receive the cartridge **100** in a removable fashion therein. In this way, the entire system **10** can be recharged by swapping out one cartridge **100** for another without requiring any connecting or disconnecting of conduits, wires or other structures.

With particular reference to FIGS. **4** through **6** details of the heat transfer fluid reservoir **20** are described, according to a preferred embodiment of this invention. The reservoir **20** provides the location where excess heat transfer fluid is contained before passing through the heat transfer fluid pathways, passing through various portions of the vest **40** and heat exchange pouch **80** according to this invention. The reservoir **20** is preferably in the form of an enclosure which is carried within the backpack **12** (FIGS. **1** through **3**) with the reservoir **20** most preferably at a lower right portion of the backpack **12** as depicted especially in FIGS. **5** and **6**. The reservoir **20** can have any of a variety of different shapes and can either be a stand alone enclosure, or can be closely integrated with adjacent elements of the system **10**.

In general, and with reference to FIG. **4**, the reservoir **20** includes an outlet **22** for delivery of heat transfer fluid out of the reservoir **20**. With reference to FIGS. **5** and **6**, the reservoir **20** can be provided with both a bypass return **24** and a pouch return **26**. The bypass return **24** delivers heat transfer fluid directly back from the vest **40** and cap **60** through the temperature control valve **70**, and without cooling through the heat exchange pouch **80**. The pouch return **26**, in contrast, returns from the heat exchange pouch **80** where it has given up significant heat to the heat sink material within the cartridge **100**, such that the heat transfer fluid from the pouch return **26** is significantly cooler than the heat transfer fluid passing through the bypass return **24** and back into the reservoir **20**. These returns **24**, **26** can join together outside of the reservoir **20** (FIG. **4**) or re-enter the reservoir **20** along separate lines (FIGS. **5** and **6**).

Most preferably, the reservoir **20** includes an air inlet **28** coupled to the air pump **130** through a prime line **134**. By delivering compressed air into the reservoir **20**, a slight pressure greater than atmospheric pressure is provided within the reservoir **20** to assist in priming the heat transfer fluid pump **30** and otherwise distributing heat transfer fluid out of the reservoir **20** and into the various heat transfer fluid pathways provided within the system **10**. Such air pressure augmentation is optional, but is included in a preferred embodiment of this invention.

With continuing reference to FIGS. 4 through 6, details of the heat transfer fluid pump of this invention are described, according to a preferred embodiment. For proper operation of the system 10, it is important that the heat transfer fluid move along the heat transfer fluid pathways which generally form a circuit extending out of the reservoir 20 and back to the reservoir 20 after passing through the vest 40, cap 60, and optionally either through the heat exchange pouch 80, or the bypass line 90 before returning back to the reservoir 20. The pump 30 acts as the prime mover to circulate the heat transfer fluid along this heat transfer fluid pathway.

The pump 30 is preferably driven by a motor 31 which is powered by batteries 32 (FIG. 1) contained within the small compartments in an upper portion of the backpack 12. Most preferably the pump 30 requires 6 volts and can be adequately powered by four 1.5 volt batteries, such as "D" cell batteries oriented in series. Motors 31 having different power needs can be powered by different battery arrangements depending upon the particular specifications of the motor 31 actually utilized.

Preferably a pair of filters are strategically located as shown along the heat transfer fluid pathway to remove debris to protect the pump 30 such that any particulates within the heat transfer fluid are removed before passing through the pump 30. The pump 30 then delivers elevated pressure fluid to the supply line 34 (FIG. 4). This supply line 34 extends to disconnect 36 before entering a garment inlet 38 leading to some portion of garment of the system 10, such as the vest 40 or cap 60. Most preferably this garment inlet 38 is the first fluid inlet 42 of the vest 40 (FIG. 5). Alternatively, the garment inlet 38 can be any form of garment adapted to receive heat transfer fluid for cooling of the wearer W.

In the depiction of this invention shown in FIGS. 5 and 6, the pump 30 is shown adjacent the reservoir 20 rather than in line with the outlet 22 of the fluid reservoir 20 leading to the first fluid inlet 42 of the vest 40. This depiction shown in FIGS. 5 and 6 provides the general relationship of the various different components of this invention, with the most precise heat transfer fluid routing most accurately shown in FIG. 4. The pump 30 can be integrated with the reservoir 20 so that at least an impeller portion of the pump 30 extends into the reservoir 20 and with the filter 33 located within the reservoir 20 such that the supply line 34 downstream from the pump 30 can be the same as the outlet 22 from the fluid reservoir 20 depicted in FIGS. 5 and 6. The electric wiring showing delivery of electric current from the batteries 32 (FIG. 1) to the motor 31 (FIGS. 5 and 6) is not shown to enhance clarity of the features that are shown in FIGS. 5 and 6.

Most preferably, the motor 31 and pump 30 are configured to minimize the possibility of motor 31 or pump 30 damage if the system 10 is not operating properly. As an example, the motor preferably includes a safety shut off system that shuts off the motor 31 and pump 30 if the motor is drawing too much current for an extended period of time. For instance, if the pump 30 is cavitating, or one of the lines in the heat transfer fluid pathway is crimped, or otherwise blocked, the motor 31 might cavitate or run in a dry state, potentially running the motor 31 too fast and/or the pump running without proper lubrication, and damaging the motor 31 or pump 30. When such high current draw conditions are maintained for a pre-set amount of time (i.e. 30 seconds), the safety system shuts off the motor 31.

The disconnect 36 is provided along the supply line 34 and before the garment inlet 38 so that the backpack 12 and associated equipment such as the pump 30 can be removed while portions of the garment, such as the vest 40 and cap 60, can continue to be worn. This facilitates swapping out of

equipment, solo resupply of fresh cartridges 100, repair of equipment located within the backpack 12, and mere removal of the backpack 12 when the individual is entering an environment where less heat stress is likely and it is desirable that the wearer W bear less weight. The disconnects 36, 170 are configured to release merely by tension pulling thereon, such that disconnection is simplified, especially for rapid removal of the backpack 12.

With particular reference to FIGS. 13 through 16 and 19 through 21, particular details of the vest 40 of this invention are described, according to a preferred embodiment. The vest 40 provides one portion of a preferred form of garment for causing heat transfer out of the body of the wearer W and into the heat transfer fluid for delivery to the heat sink, such as the cartridge 100 and heat sink material contained within the cartridge 100, such as water L/ice I. Other forms of garments could be provided in addition to the vest 40 or in replacement of the vest 40.

Most preferably, the vest 40 is not merely a single large compartment. Rather, the vest 40 is divided into an elongate pathway along which the heat transfer fluid passes while passing through the vest 40. As particularly depicted in FIG. 16, the vest 40 preferably includes a first fluid inlet 42 where the heat transfer fluid first enters the vest 40. A rising path 43 is provided extending up from the first fluid inlet 42 around a perimeter of the vest 40 and to the first fluid outlet 44. This rising path 43 is primarily provided to most conveniently deliver the heat transfer fluid up to the cap 60. It is typically preferable to cool the head H of the wearer W, such as through the cap 60, before providing heat transfer out of the wearer W through the vest 40. Thus, this rising path 43 passes relatively directly from the first fluid inlet 42 to the first fluid outlet 44. A cap supply tube 45 then takes the heat transfer fluid from the first fluid outlet 44 up to the cap 60.

When the heat transfer fluid is returning from the cap 60, the vest 40 is adapted to again receive the heat transfer fluid at a second inlet 46 feeding a first falling path 47 and second falling path 48 within the vest 40. These paths 47, 48 are generally parallel to each other as they wind down from the second inlet 46 to a second outlet 49 at a bottom of the vest 40. A bulk of the vest 40 is comprised of the paths 47, 48, where a bulk of heat transfer out of the torso T of the wearer W occurs.

The particular orientation of the paths 43, 47, 48 can be adjusted as desired. In general, making the paths 43, 47, 48 narrower increases the friction losses as the heat transfer fluid passes through the vest 40, but minimizes any stagnation pockets along the paths 43, 47, 48 where heat transfer fluid might stop moving or move more slowly than other portions of the heat transfer fluid. The size of the vest 40, and the constitution of the heat transfer fluid, as well as the power of the pump 30 are all factors which bear on how best to configure the paths 43, 47, 48 within the vest 40. A most preferred form of heat transfer fluid currently contemplated is a 50/50 mix of propylene glycol and water with 0.25% of a wetting agent and an iodine tincture.

With particular reference to FIGS. 20 and 21, particular additional details of the vest 40 are described. In particular, the vest 40 is generally in the form of an inner layer and an outer layer which are generally parallel to each other with a heat transfer fluid space between these two layers. In FIGS. 16, 20, and 21 an outer layer has been removed so that interior details of the vest 40 including the orientation of the paths 43, 47, 48, can be shown.

A border 52 defines an ultimate perimeter of the vest 40 where these inner and outer layers are bonded together so that the heat transfer fluid space between the inner layer and the

outer layer is entirely enclosed, except where the fluid inlets **42**, **46** and fluid outlets **44**, **49** are provided.

Most preferably, the vest **40** is configured with a plurality of dots **50** extending between the inner layer and the outer layer. These dots **50** are preferably formed by radio frequency welding the inner layer and outer layer formed of plastic material together. These dots **50** help to maintain a relatively constant thickness of the vest **40** between the inner layer and the outer layer. Also, the dots **50** encourage mixing of the heat transfer fluid as it passes along the various different paths within the vest **40**.

The dots **50** are preferably substantially round, but could be square, rectangular or exhibit other faceted or curved forms, being primarily non-elongate, but rather mostly residing near a central point. The dots **50** are preferably substantially uniformly spaced from each other and occupy a generally hexagonal pattern with the dots **50** adjacent a central dot **50** spaced about sixty degrees from each other. The dot **50** spacing is most preferably 0.32 inches, and configured to cause the inner layer and outer layer of the vest **40** to be spaced <0.10 inches from each other. The dot spacing is preferably optimized to account for various parameters including the peel strength of the material, the operating pressure of the fluid in the garment, the weight and volume of the heat transfer fluid, the skin thermal conductance, and the ratio of dot area to conductance area. In some instances, these parameters can dictate dot **50** spacing of 0.30 inches or less or 0.35 inches or more. The vest **40** layer spacing can conceivably increase in some instances to 0.15 inches or even 0.20 inches or more under some conditions.

Additionally, fences **51** are provided extending between the inner layer and the outer layer. These fences **51** cause the heat transfer fluid space within the vest **40** to be broken into the heat transfer fluid pathway extending between the inlets **42**, **46** and the outlets **44**, **49**. The fences **51** preferably are aligned with the dots **50** such that no dots **50** are close to the fences **51**, but so that the fences **51** are either generally a maximum distance away from the dots **50** or intersect the dots **50**. Following such criteria, the fences **51** have a generally highly irregular serpentine configuration. The fences **51** are similarly formed by bonding the inner layer and the outer layer together, such as by radio frequency radiation bonding together.

Additionally, the vest **40** preferably includes shoulder straps **55** (FIGS. **13** through **16**) to assist in holding the vest **40** where desired adjacent the torso **T** of the wearer **W**. A sternum joint **56** is provided to join two of the borders **52** of the vest **40** together so that the vest **40** can entirely gird the torso **T** of the wearer **W**. This sternum joint **56** preferably includes a plurality of tabs **57** with eyelets **58** in each of the tabs **57**. Laces **59** are added through the eyelets **58** and each of tabs **57** so that tightening of the laces **59** cause the vest **40** to be tightened. If required, the sternum joint **56** can include an intermediate structure, generally in the form of a spacer (FIG. **19**), so that a length of the laces **59** can be minimized and the sizing of the vest **40** can be varied. The vest **40** would typically preferably be provided in different sizes to accommodate wearers **W** of different sizes, and yet be somewhat adjustable.

With particular reference to FIGS. **13** through **15**, **18**, **20**, and **21**, particular details of the cap **60** are described, according to a preferred embodiment. The cap **60** provides a heat transfer garment which is particularly configured to remove heat from the head **H** of the wearer **W** and into the heat transfer fluid for cooling of the head **H** of the wearer **W**. The cap **60** preferably includes layering and dots **50** similar to those described above with regards to the vest **40**. However,

the cap **60** preferably does not include fences **51**, but rather relies on having an elongate shape defined by borders **52**.

In particular, the cap **60** preferably includes an inlet **61** which is adapted to be coupled to the cap **60** supply tube **45**. Heat transfer fluid pathways within the cap **60** include a left forward path **62** which extends from a base of the skull of the head **H** of the wearer **W** when the cap **60** is on the head **H** of the wearer **W** toward a crown of the head **H**. After reaching the crown, the left forward path **62** transitions into a left return path **63** which generally curves around the left ear on the head **H** of the wearer **W** and terminates at a left outlet **64** on a left side of the base of the head **H**, adjacent the inlet **61**.

Similarly, a right forward path **65** is provided extending forward and then connecting to a right return path **66** which extends back to a right outlet **67**. The right forward path **65**, right return path **66** and right outlet **67** are preferably substantially mirror images of the left forward path **62**, left return path **63** and left outlet **64**.

Tabs, eyelets and laces are preferably provided similar to those described above with regard to the vest **40**, so that the paths **62**, **63**, **65**, **66** of the cap **60** can be drawn tightly together and so that these paths **62**, **63**, **65**, **66** take on a generally spherical form adapted to fit snugly over the head **H** of the wearer **W** (FIGS. **13** through **15**). The left outlet **64** and right outlet **67** feed into a "Y" tube **68** where fluid flow from these two outlets **64**, **67** join together before the fluid is directed to the second inlet **46** at an upper portion of the vest **40**.

Most preferably, ear covers **69** are also provided with tabs and eyelets so that they can be laced to the cap **60** and assist in securing the cap **60** securely to the head **H** of the wearer **W**. These ear covers with chin straps **69** extend under the chin of the wearer **W** and provide a location for snaps **5** on strap **4** of the helmet **2** to connect, when the helmet **2** is to be worn over the cap **60** (FIGS. **2** and **3**). Particular detail regarding how the laces **59** are utilized along with the tabs **57** and eyelets **58** are shown in detail in FIG. **20**.

With particular reference to FIGS. **4** through **6** details of the temperature control valve **70** are described, according to a preferred embodiment. After the heat transfer fluid exits the second outlet **49** of the vest **40**, the heat transfer fluid has drawn heat from the wearer **W** and so a temperature of the heat transfer fluid has been increased to a point where it can typically no longer effectively draw additional heat from the wearer **W**.

It is thus important that this heat transfer fluid be cooled before re-circulating back to the vest **40**, cap **60**, or other heat transfer garment. On the other hand, if the heat transfer fluid is too effectively cooled, the heat transfer fluid can be re-circulated to the vest **40**, cap **60** or other heat transfer garment at too cool of a temperature and cause the wearer **W** to experience an uncomfortably too cool temperature. Accordingly, it is desirable according to a preferred embodiment to have a temperature control valve through which the wearer **W** can control a temperature of the heat transfer fluid and thus a rate at which heat is removed from the wearer **W**. Alternatively, this temperature control valve **70** can be thermostatically controlled, such as with a temperature sensor in the heat transfer fluid and with the temperature control valve **70** adjusted based on the temperature reading received by this temperature sensor.

The temperature control valve **70** includes an input **72** receiving the elevated temperature heat transfer fluid from the vest **40** or other garment. The input **72** then leads to a flow splitter **73** within the temperature control valve **70**. The flow splitter **73** acts as a divider to divide the flow between a bypass outlet **74** and a cooling outlet **76**. A controller **78**, such as a dial is provided to adjust the flow splitter **73** and adjust a

proportion of the heat transfer fluid which is directed to the bypass outlet **74** and to the cooling outlet **76**.

The bypass outlet **74** leads to a hot path and the cooling outlet **76** leads to a cold path for the heat transfer fluid. The hot path connects to the bypass line **90** and returns directly to the reservoir **20** without cooling. The cold path extends to the heat exchange pouch **80** where the heat transfer fluid is cooled before returning to the reservoir **20**. Thus, when a greater amount of the heat transfer fluid is directed to the cold path and the heat exchange pouch **80** by adjusting of the temperature control valve **70**, the heat transfer fluid is cooled to a greater extent before returning back to the vest **40** and the cap **60** or other heat exchange garment, for an increased amount of cooling of the wearer **W**. When a greater amount of the heat transfer fluid is passed through the bypass outlet **74** to the bypass line **90**, the heat transfer fluid is cooled to a lesser extent so that when it is returned to the vest **40**, cap **60** or other heat transfer garment, the wearer **W** receives a lesser degree of cooling.

As depicted in FIGS. **5** and **6**, the temperature control valve **70** is shown at a lower rear left side of the backpack **12** (FIG. **1**). However, this position for the temperature control valve **70** could be altered, such as by rotating further to the side of the wearer **W** so that the wearer **W** can see the temperature control valve **70** while adjustment takes place. Typically, the dial or other controller **78** extends out of the backpack **12** to facilitate manual adjustment by the wearer. Indicia can be printed adjacent this dial **78** and the dial **78** can be fitted with detents so that a user can most conveniently tell what setting is currently selected for the valve **70**.

With particular reference to FIGS. **4** through **6** and **9**, details of the heat exchange pouch **80** are described, according to a preferred embodiment. The heat exchange pouch **80** provides a region where the heat exchange fluid can be brought into close proximity with the cartridge **100** so that heat transfer can occur from the heat transfer fluid to the heat sink material, such as ice **I** or liquid water **L** within the cartridge **100**.

The heat exchange pouch **80** (FIG. **6**) generally has a configuration somewhat similar to that of the vest **40**. In particular, the heat exchange pouch **80** includes an inside layer **82** generally parallel with a mid-layer **84**, under which a heat transfer fluid space **85** between the layers **82**, **84** resides. Preferably, dots, such as the dots **50** of the vest **40** (FIG. **21**) are provided joining the inside layer **82** and mid layer **84** together.

The inside layer **82** is oriented to come into direct contact with the cartridge **100**. The layers **82**, **84** are sealed together at peripheral borders thereof, except where inlets and outlets are provided, such as the fluid entrance **88** and fluid exit **89** (FIG. **6**).

Most preferably an outside layer **86** is provided outside of the mid layer **84** with an air space **87** between the mid layer **84** and outside layer **86**. This air space **87** is preferably in communication with the source of elevated pressure air. When elevated pressure air is placed in the air space **87**, it causes the heat transfer fluid space **85** and particularly the inside layer **82** to be pressed into intimate contact with the cartridge **100** to maximize heat transfer through the inside layer **82**, cartridge **100** and to the heat sink material such as ice **I** or liquid water **L**.

While FIG. **6** depicts the heat exchange pouch **80** without any fences extending between the layers **82**, **84**, typically some form of fences would be provided so that the heat transfer fluid is routed along a path between the layers **82**, **84**. Also, the fluid entrance **88** and fluid exit **89** are preferably spaced from each other so that only the most fully cooled heat

transfer fluid is removed from the heat exchange pouch **80** after maximum residence time of the heat transfer fluid within the heat exchange pouch **80** has occurred. The heat exchange pouch **80** can be either provided merely on a rear side of the compartment of the backpack **12** in which the cartridge **100** is located, or the heat exchange pouch **80** can be provided to wrap around both lateral sides, to and bottom ends, and optionally a front side of this compartment so that the heat exchange pouch **80** transfers heat into the cartridge **100** from all sides. This compartment is preferably sized approximately the same size as the cartridge **100** so that the cartridge **100** is securely held within the compartment when the large zipper **18** (FIG. **1**) is closed.

With particular reference to FIGS. **4** and **6** through **9**, details of the cartridge **100** of this invention are described, according to a preferred embodiment. The cartridge **100** provides a preferred form of walled enclosure for a heat sink material which is provided to draw heat away from the heat transfer fluid passing along the heat transfer fluid pathway within the system **10** of this invention. Most preferably, the heat sink material is drinkable in liquid form, and is optimally water **L**/ice **I** either in pure form or with additives to provide desirable flavor and/or performance enhancing characteristics (i.e. electrolytes, vitamins, minerals, nutritional content, etc.).

The cartridge **100** is removable from the system **10** and replaceable with another cartridge **100**, such as when the cartridge **100** is empty or has been heated to the point where it is desirable to replace the cartridge **100** with a new cooled cartridge **100**. The cartridge **100** is preferably formed from an injection moldable plastic material with appropriate stiffeners so that the cartridge **100** maintains a similar shape either when containing water **L** in liquid form or ice **I**. Most preferably, the compartment in which the cartridge **100** resides can accommodate some slight expansion of the cartridge **100** associated with the expansion of the water when freezing. As an alternative, the cartridge **100** could be formed of a higher heat transfer rate material such as aluminum, or some other suitable material.

The cartridge **100** according to the preferred embodiment includes a wall **101**, a generally elongated oval form when viewed in full section from above. Stiffener ribs **102** are provide girding the cartridge **100** horizontally to enhance the stiffness of the cartridge **100**. A spine **103** preferably passes entirely from a front side of the cartridge **100** to a rear side of the cartridge **100** so that an interior **105** of the cartridge **100** is generally divided between left and right halves except above and below the spine **103**. A handle slot **104** is preferably provided near an upper portion of the cartridge **100** to facilitate ease in handling the cartridges **100**. An upper end of the cartridge **100** preferably includes an air port **106** therein which has a nuclear biological hazard filter **108** mounted thereon. The water outlet valve **110** is located at a lower end of the cartridge **100** opposite the air port **106**.

The spine **103** and stiffener ribs **102** not only assist in maintaining the rigidity of the cartridge **100** and minimizing the weight of the cartridge **100**, but also assist in minimizing the sloshing of ice **I** within liquid water **L** in the interior **105** of the cartridge **100**. In particular, when the ice **I** is frozen, the cartridge **100** starts out with a complete block of ice **I**. As the ice **I** melts into liquid water **L**, the ice **I** remains one large chunk. As heat transfer generally occurs from the walls **101** of the cartridge **100** in towards the spine **103**, this large chunk of ice **I** remains secured to the spine **103** and somewhat maintained in place by the stiffener ribs **102**. Thus, the ice **I** does not tend to shift in a way that would be uncomfortable to the wearer **W** or affect the balance of the wearer **W**. Once the ice

13

I has melted to the point where it has broken off of the spine **103**, typically enough of the liquid water L has been removed, to the drinking tube **120** as described below, that shifting of ice I and liquid water L within the cartridge **100** is not of significant concern.

As the liquid water L is removed from the cartridge **100** through the drinking tube **120**, the air port **106** allows air to be drawn into the cartridge **100** to replace the water L that is being removed. As an alternative, the cartridge **100** could be entirely sealed and provided with flexible walls so that the cartridge **100** would merely collapse as liquid water L is removed through the drinking tube **120**. As another alternative, the drinking tube **120** and water outlet valve **110** could be eliminated and the cartridge **100** could merely be provided as a removable heat sink that would be replaced once the heat sink has heated to a temperature where rates of heat transfer are no longer adequate.

With particular reference to FIGS. **10** through **12**, details of the water outlet valve **110** are described, according to this invention. The cartridge **100** is designed so that it can be readily swapped with another cartridge **100** within the system **10**, with a minimum of inconvenience. Accordingly, the water outlet valve **110** is provided within a lower portion of the heat exchange pouch **80** within the backpack **12** to be aligned with a plug **111** at a lower end of the cartridge **100**. Both the water outlet valve **110** and the plug **111** each include valve elements **115**, **119** to seal off the water outlet valve **110** in cartridge **100**, except when the cartridge **100** is secured in place adjacent the water outlet valve **110**.

In particular, the plug **111** includes a throat **112** in communication with the interior **105** of the cartridge **100** and inside of a neck **113** extending down from the cartridge **100**. A sealing ring **115** surrounds a perimeter of the plug **111** to prevent leakage after the cartridge **100** is secured within the water outlet valve **110**.

The valve element **115** is located within the throat **112** at a tip thereof. The water outlet valve **110** includes a receiver **116** which is in the form of a cylindrical space sized to receive the plug **111** therein when the cartridge **100** is pushed down into the water outlet valve **110**. The receiver **116** has a tapering rim **117** to assist in guiding the plug **111** into proper mating relationship inside the receiver **116**.

A locking ring **118** resides within a groove surrounding the receiver **116** and is configured to snap into the neck **113** in the plug **111** to secure the plug **111** of the cartridge **100** within the water outlet valve **110** receiver **116**. This locking ring **118** is sufficiently resilient that when the cartridge **100** is pushed down so that the plug **111** extends into the water outlet valve **110**, the locking ring **118** is expanded and the plug **111** can seat entirely down into the receiver **116**. In a similar fashion, the cartridge **100** can be securely grabbed, such as with the handle slot **104**, and lifted upwards so that the locking ring **118** can resiliently expand and release out of the neck **113** in the plug **111** so that the cartridge **100** can be removed from the water outlet valve **110**.

When the plug **111** is seated down securely within the receiver **116** a tip of the valve element **115** within the plug **111** abuts a tip of the valve element **119** within the receiver **116** of the water outlet valve **110**. These valve elements **115** are each spring loaded to bias them into a closed position. However, when they abut each other, sufficient forces are applied so that the springs can be compressed and the valve elements **115**, **119** opened. Most typically, initially the cartridge **100** is filled with ice I and this ice I within the throat **112** blocks the valve element **115** from initially moving when the valve element **115** abuts the valve element **119** of the water outlet valve **110**. The spring of the valve element **119** has sufficient travel so

14

that the valve element **119** can entirely open and the cartridge **100** entirely seat with the plug **111** entirely into the receiver **116** even when the valve element **115** cannot move because the ice I is frozen (see particularly FIG. **11**). After the ice I begins to melt, the valve element **115** can move (FIG. **12**) so that both the valve element **115** and valve element **119** are open. Most preferably, the spring in the valve element **115** is stronger than the spring in the valve element **119**, and has less travel, so that when the ice I melts, the valve element **115** can work against the fully open valve element **119** so that both valve elements **119** achieve an open position. Limited travel for the valve element **115** assures that the valve element **115** does not close the valve element **119**.

Liquid water L can then flow through the valve element **115** and valve element **119** so that drinking water is supplied through the water outlet valve **110** from the cartridge **100** and into the drinking tube **120**. A pathway through the valve elements **115**, **119** is shown in broken lines in FIGS. **10** to **12**.

With particular reference to FIGS. **1**, **3**, **4** and **6**, details of the drinking tube **120** of this invention are described. The drinking tube **120** is preferably in the form of an elongated flexible straw which extends from the water outlet valve **110** up to a portion of the backpack **12** near the head H of the wearer W, where the wearer W can conveniently suck on a tip **126** of the drinking tube **120**. The drinking tube **120** extends from the source **122** adjacent the water outlet valve **110** along the line **124** and up to the tip **126** with routing being variable either within an interior of the backpack **12** or on an exterior of the backpack **12**.

When the wearer W sucks on the tip **120** of the drinking tube **120**, a slight vacuum causes liquid water L to flow out of the cartridge **100** through the water outlet valve **110** and up to the tip **126** for drinking. When the cartridge **100** is still mostly frozen, the user can alternatively suck and blow to apply forces on the valve elements **115**, **119** to free up the valve elements **115**, **119** and cause them to open so that liquid water L can flow through the water outlet valve **110**. Thus, the cartridge **100** not only provides for cooling of the heat transfer fluid, but also provides a convenient source for drinking water L or other hydration fluid for the benefit of the wearer W.

With particular reference to FIGS. **4** through **6** details of the air pump **130** are described. In a most basic form of this invention, it is conceivable that the air pump **130** could be omitted. Most preferably, however, the air pump **130** is utilized so that a source of slightly elevated pressure air is provided to optimize performance of the system **10**. In particular, the air pump **130** is powered by a motor **131** receiving electric power from batteries **132** (FIG. **4**). Most typically, the air pump **130** has lower power than the heat transfer fluid pump **30**, such that conceivably only three volts of electric potential are required and, as an option, only two of the four batteries can be utilized for powering the air pump **130**.

A filter **133** is preferably provided so that contamination of air passing into the air pump **130** is avoided. The air pump **130** provides various different lines where pressurized air can be of assistance in operation of the system **10**. For instance, a prime line **134** extends to the reservoir **20** so that air within the reservoir **20** can be of a slightly elevated pressure and assist in priming the heat transfer fluid pump **30**, and avoid contamination or other damage to the heat transfer fluid **20** should air bubbles be present in the heat transfer fluid. An auxiliary outlet line **135** is provided where any auxiliary air pressure power systems can be coupled to the system **10** of this invention.

A pouch line **136** is provided which passes to the air space **87** of the heat exchange pouch **80** described in detail above. A cummerbund line **137** passes to the cummerbund **140** where

15

air pressure can assist in pressing the vest **40** against the wearer **W** for maximum heat transfer. An air valve **139** is preferably provided adjacent the air pump **130** to allow further control of the air pump **130** of the system **10**. A heat transfer fluid pressure line **138** is also provided which allows

air to mix with the heat transfer fluid before return to the reservoir **20** and to assist in maintaining positive pressure for the heat transfer fluid pathway.

With particular reference to FIGS. **4**, **13** through **15**, and **17**, details of the cummerbund **140** of this invention are described, according to a preferred embodiment. The cummerbund **140** is optionally provided to enhance heat transfer between the vest **40** and the wearer **W**. In particular, the cummerbund **140** includes an air inlet **141** passing into a series of columns **142** spaced apart by dividers **143**. These columns **142** and dividers **143** keep the cummerbund **140** in a generally low profile form. A front closure **145** is provided similar to the sternum joint **56** of the vest **40** so that the cummerbund **140** can gird the wearer **W** about the torso **T**.

With particular reference to FIG. **4**, details of a heat transfer fluid filler source **150** are described. At times it is required that heat transfer fluid be provided to initially fill the various different heat transfer fluid pathways of the system **10**, or to replace lost fluid, or to recharge the system **10** and replace contaminated or otherwise deteriorated heat transfer fluid. Most preferably, a heat transfer fluid filler source **150** is provided which includes a tank **152** of new heat transfer fluid. An outlet **154** is provided which feeds to a portion of the heat transfer fluid pathway just upstream from the heat transfer garment, such as the vest **40** or cap **60**. The tank **150** can be provided under pressure so that this pressure is utilized to drive the heat transfer fluid into the vest **40**, cap **60** and into the various different lines making up the heat transfer fluid pathway, without requiring that the pump **30** be simultaneously operational at a time when it might be dry. One way to pressurize the tank **150** and drive the heat transfer fluid out of the tank **150** and into the system **10** is to make the pump **30** reversable, and configure the pump **30** within the system to allow it to so operate. Most preferably, the pump **30** is a form of gear pump to particularly facilitate such reversability. Either a transmission or reversable motor **31** are utilized to drive the pump **30** in the reverse direction when so required.

As air or contaminated heat transfer fluid is driven out of the various heat transfer fluid pathways and returned back to the reservoir **20**, a potential over pressure condition within the reservoir **20** is avoided by having an air/overflow inlet **156** extending from the reservoir **20** back to the heat transfer fluid filler source **150**. Once the system has been entirely charged, the heat transfer fluid filler source **150** can be disconnected from the system **10**.

With further reference to FIG. **4**, various check valves **160** are provided to maintain a desired direction of heat transfer fluid flow through the system and a desired direction of air flow through the system, as well as to keep the heat transfer fluid out of the air lines and to maintain elevated pressure within desired portions of the heat transfer fluid and air pathways. Also, miscellaneous disconnects **170** are provided at various different locations within the system **10**. These disconnects allow the various different subcomponents of the system **10** to be readily attached and detached such as during maintenance.

This disclosure is provided to reveal a preferred embodiment of the invention and a best mode for practicing the invention. Having thus described the invention in this way, it should be apparent that various different modifications can be made to the preferred embodiment without departing from the scope and spirit of this invention disclosure. When struc-

16

tures are identified as a means to perform a function, the identification is intended to include all structures which can perform the function specified. When structures of this invention are identified as being coupled together, such language should be interpreted broadly to include the structures being coupled directly together or coupled together through intervening structures. Such coupling could be permanent or temporary and either in a rigid fashion or in a fashion which allows pivoting, sliding or other relative motion while still providing some form of attachment, unless specifically restricted.

What is claimed is:

1. A personal cooling and hydration system, comprising in combination:

- a heat transfer fluid;
- said heat transfer fluid contained within a heat transfer fluid pathway;
- said pathway adapted to be located proximate to a body of a person, such that heat can be transferred from the body to said heat transfer fluid when the body is hotter than said heat transfer fluid;
- a heat sink material;
- said heat sink material adapted to be drinkable;
- a walled enclosure;
- said walled enclosure adapted to hold said heat sink material within an interior thereof;
- said pathway adapted to be located proximate to an exterior of said walled enclosure, such that heat can be transferred from said heat transfer fluid to said heat sink material when said heat transfer fluid is hotter than said heat sink material;
- an outlet for said heat sink material to facilitate drinking thereof; and
- wherein an elevated pressure air space is located on a side of said pathway opposite said walled enclosure where said pathway is located proximate to said exterior of said walled enclosure, such that said elevated pressure air space applies a force tending to press said pathway against said exterior of said walled enclosure.

2. The system of claim **1** wherein said pathway is at least partially configured as a circuit with a pump therein, said pump adapted to circulate said heat transfer fluid within said circuit.

3. The system of claim **1** wherein said walled enclosure is configured as a cartridge, said cartridge adapted to be removably replaced from adjacent said pathway, such as for replacement with a new second cartridge colder than said cartridge previously adjacent said pathway.

4. The system of claim **3** wherein said pathway includes a pouch, said pouch having a heat transfer surface inside layer adapted to surround said cartridge and separate said heat transfer fluid pathway and said heat transfer fluid from said walled enclosure of said cartridge.

5. The system of claim **4** wherein said pouch is located within a backpack adapted to be worn by the person.

6. The system of claim **5** wherein said pathway includes a vest adjacent a torso of the person, said vest including an inner layer adapted to separate said heat transfer fluid from the torso of the person, said inner layer adapted to allow heat transfer from the torso of the person to said heat transfer fluid within said pathway within said vest.

7. The system of claim **6** wherein said pathway includes a cap adapted to be worn upon a head of the person, said cap adapted to deliver said heat transfer fluid adjacent the head of the person while keeping said heat transfer fluid from directly contacting the head of the person and allowing heat transfer between said heat transfer fluid and the head of the person.

17

8. The system of claim 1 wherein an elevated pressure air space is located adjacent said pathway where said pathway is located proximate to the body of the person and with said elevated pressure air space on a side of said pathway opposite said person, such that said elevated pressure air space tends to apply a force on said pathway encouraging said heat transfer fluid within said pathway into intimate contact with the body of the person.

9. The system of claim 1 wherein said pathway includes a hot path and a cold path in parallel with each other, said cold path adapted to give more heat from said heat transfer fluid to said heat sink material than said hot path, and a divider in said pathway, said divider adapted to adjustably split said heat transfer fluid between said hot path and said cold path.

10. An easily and quickly rechargeable personal cooling and hydration system, comprising in combination:

a cartridge adapted to be filled with a drinkable heat sink material;

a heat sink material outlet coupled to said cartridge;

a heat transfer fluid contained within a heat transfer fluid pathway, said pathway routed past and in heat exchange relationship with said cartridge;

said pathway also adapted to be routed past and in heat exchange relationship with a body of a person to be cooled;

said cartridge adapted to be swapped with another similar cartridge, such as when a first said cartridge is empty or no longer sufficiently cool;

wherein said pathway includes a pouch, said pouch sized to receive said cartridge therein, said pouch including an inside layer adapted to reside between the heat transfer fluid and said cartridge, while facilitating heat transfer from the heat transfer fluid to the heat sink material within said cartridge; and

wherein said pouch includes an elevated pressure air space on a side of said pathway opposite said cartridge, such that said elevated pressure air space tends to apply a

18

force pressing said pathway and said inside layer against said cartridge, such that heat transfer between said heat transfer fluid within said pathway and the heat sink material within said cartridge is enhanced.

11. The system of claim 10 wherein said pathway includes at least one garment item having an inner layer adapted to be closer to the body of the person, and an outer layer adapted to be further from a body of the person than said inner layer, said inner layer and said outer layer spaced apart by width of said pathway, said inner layer and said outer layer adapted to be suspended upon a portion of the body of the person, such that said pathway is worn by the person.

12. The system of claim 11 wherein said pathway includes a vest portion, said vest portion adapted to be worn upon a torso of the person.

13. The system of claim 12 wherein said pathway includes a cap portion adapted to worn upon a head of the person.

14. The system of claim 10 wherein said pathway includes a hot path and a cold path in parallel with each other on at least a portion of said pathway, said cold path adapted to give more heat from the heat transfer fluid to said heat sink material within said cartridge than said hot path, and a divider in said pathway, said divider adapted to adjustably split the heat transfer fluid between said hot path and said cold path.

15. The system of claim 10 wherein said cartridge includes an air inlet therein, such that as drinkable heat sink material is removed from said cartridge air can enter said cartridge to replace the heat sink material.

16. The system of claim 15 wherein said air inlet includes a nuclear and biological hazardous material filter.

17. The system of claim 10 wherein said cartridge includes a spine passing entirely through a central portion of said cartridge, such that an interior of said cartridge completely surrounds said spine except where said spine joins with walls forming said cartridge, said spine passing from a forward side of said cartridge to a rearward side of said cartridge.

* * * * *